

Write your name here	
Surname	Other names
<b>Pearson Edexcel</b>	Centre Number
<b>International GCSE</b>	Candidate Number
<h1 style="margin: 0;">Human Biology</h1> <p style="margin: 5px 0;"><b>Unit: 4HB0</b></p> <p style="margin: 5px 0;"><b>Paper: 01</b></p>	
Wednesday 11 May 2016 – Morning	Paper Reference
<b>Time: 2 hours</b>	<b>4HB0/01</b>
<b>You must have:</b> Ruler Calculator	Total Marks

### Instructions

- Use **black** ink or ball-point pen.
- **Fill in the boxes** at the top of this page with your name, centre number and candidate number.
- Answer **all** questions.
- Answer the questions in the spaces provided  
– *there may be more space than you need.*
- Show all the steps in any calculations and state the units.
- Some questions must be answered with a cross in a box ☒. If you change your mind about an answer, put a line through the box ☒ and then mark your new answer with a cross ☒.

### Information

- The total mark for this paper is 120.
- The marks for **each** question are shown in brackets  
– *use this as a guide as to how much time to spend on each question.*

### Advice

- Read each question carefully before you start to answer it.
- Write your answers neatly and in good English.
- Try to answer every question.
- Check your answers if you have time at the end.

*Turn over* ►

P45936A

©2016 Pearson Education Ltd.

1/1/1/1/1/1/1/1/



PEARSON

**Answer ALL questions.**

- 1 For each of the questions (a) to (j), choose an answer **A, B, C** or **D** and put a cross in the box . Mark only one answer for each question. If you change your mind about an answer, put a line through the box  and then mark your new answer with a cross .

(a) A cell containing 16 chromosomes divides by mitosis producing two cells, which each contain (1)

- A** 4 chromosomes  
 **B** 8 chromosomes  
 **C** 16 chromosomes  
 **D** 32 chromosomes

(b) Semicircular canals in the ear are responsible for (1)

- A** balance  
 **B** equalising air pressure  
 **C** hearing  
 **D** transmitting vibrations

(c) The diagram shows a human tooth.

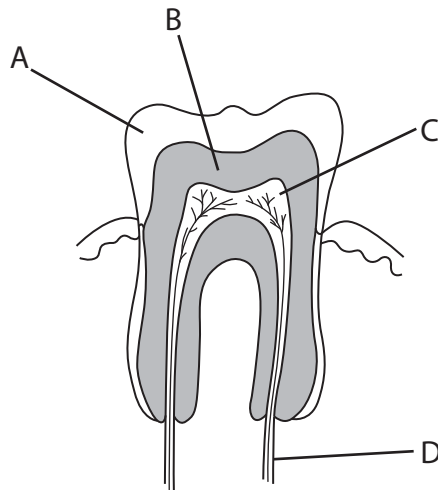

The hardest part of the tooth is labelled (1)

- A**  
 **B**  
 **C**  
 **D**

DO NOT WRITE IN THIS AREA

DO NOT WRITE IN THIS AREA

DO NOT WRITE IN THIS AREA



DO NOT WRITE IN THIS AREA

DO NOT WRITE IN THIS AREA

DO NOT WRITE IN THIS AREA

(d) Which component of a diet contains the elements carbon, hydrogen, oxygen and nitrogen? (1)

- A carbohydrate
- B fat
- C glycerol
- D protein

(e) Which disease is caused by a bacterium? (1)

- A athlete's foot
- B gonorrhoea
- C influenza
- D malaria

(f) The bacteria shown in the photograph are different from animal cells because they contain (1)



- A cytoplasm
- B a cell wall
- C chromosomes
- D a cell membrane

(g) Which of the following is not an excretory organ? (1)

- A kidney
- B lungs
- C pancreas
- D skin



(h) The position of the heart in the human body is

(1)

- A below the diaphragm
- B between the two lungs
- C in the middle of the abdomen
- D under the stomach

(i) Which of the following is **not** a greenhouse gas?

(1)

- A carbon dioxide
- B methane
- C sulfur dioxide
- D water vapour

(j) The diagram shows a section through the human brain.

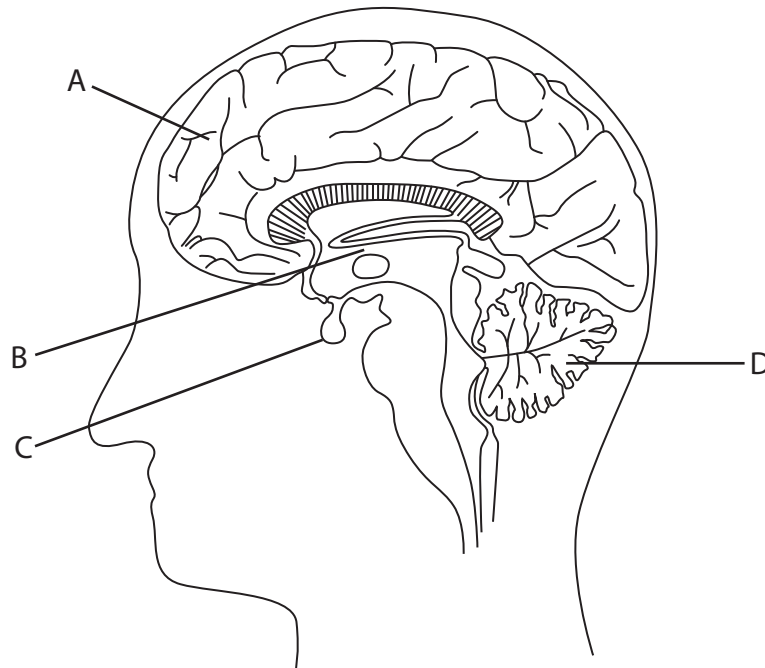

Which part is responsible for intelligence?

(1)

- A
- B
- C
- D

(Total for Question 1 = 10 marks)



DO NOT WRITE IN THIS AREA

DO NOT WRITE IN THIS AREA

DO NOT WRITE IN THIS AREA

**BLANK PAGE**



2 (a) Complete the passage using the correct word or words from the list.

(8)

atria	pumps	right atrium	body	elastic tissue
right ventricle	seventy	cardiac muscle	left ventricle	
thirty	ventricles	receive	one hundred	lungs

The human heart consists of four chambers. The upper two chambers are called the

..... and they ..... blood from the

veins.

The lower chambers are the ..... The right lower chamber pumps

blood to the ....., whilst the left lower chamber pumps blood to the

.....

The wall of the heart is made of ..... and the chamber with the

thickest wall is the .....

At rest, the average adult heart beats about ..... times a minute.

DO NOT WRITE IN THIS AREA

DO NOT WRITE IN THIS AREA

DO NOT WRITE IN THIS AREA



(b) The diagram shows a heart without any valves being drawn.

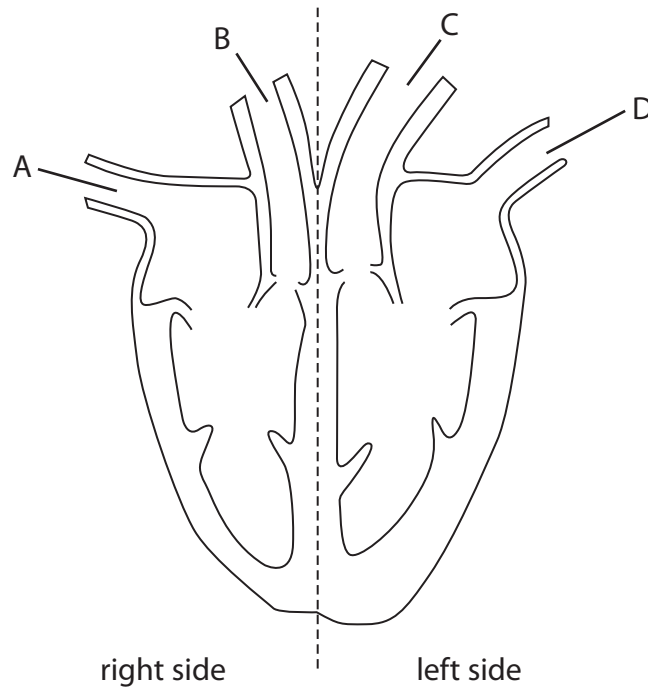

(i) Name the blood vessels A, B, C and D.

(4)

- A .....
- B .....
- C .....
- D .....

(ii) The ventricles of the heart are relaxed and filling with blood.

Complete the diagram by drawing the two sets of valves on the left side of the heart as they would appear at this stage.

(2)

(iii) Using label lines on the diagram, name the valves you have drawn.

(2)

**(Total for Question 2 = 16 marks)**



- 3 (a) A student carries out an investigation into the effect of different concentrations of sugar solution on the mass of potato cylinders.

This is the method the student uses.

- wrap each potato cylinder in filter paper
- remove each potato cylinder from the filter paper and weigh
- place each potato cylinder into a sugar solution of known concentration
- remove the potato cylinders after two hours
- wrap the potato cylinders in filter paper, then remove from the filter paper and reweigh

The results are given as a percentage change in mass of the potato cylinders. The concentration of sugar is given in arbitrary units (au).

The student's results

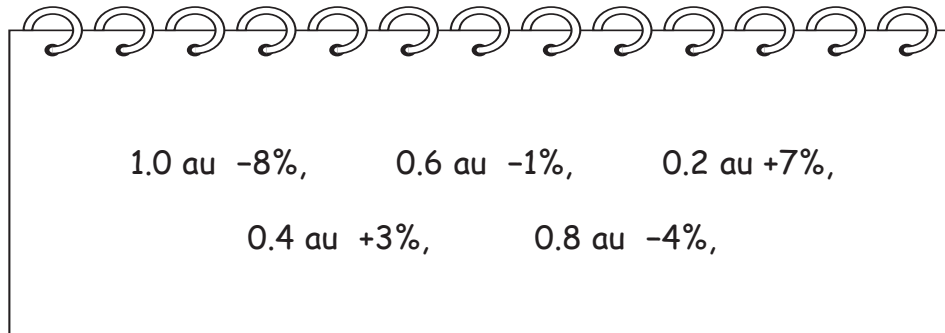

1.0 au -8%,	0.6 au -1%,	0.2 au +7%,
0.4 au +3%,	0.8 au -4%,	

- (i) Draw a table with column headings to display the student's results.

(4)



(ii) Plot a graph of the results. Draw a line of best fit.

(4)

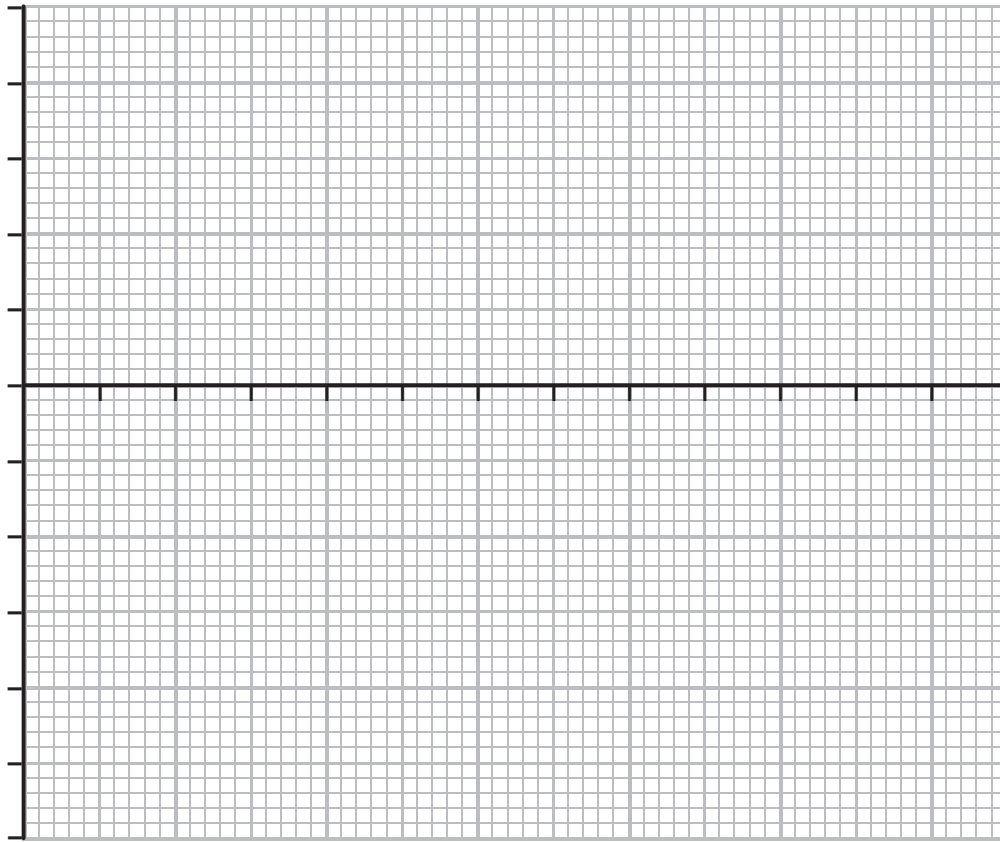

(iii) Use your graph to find the concentration of sugar that would produce no change in the mass of the potato cylinders.

(1)

concentration of sugar = ..... au

DO NOT WRITE IN THIS AREA

DO NOT WRITE IN THIS AREA

DO NOT WRITE IN THIS AREA



DO NOT WRITE IN THIS AREA

DO NOT WRITE IN THIS AREA

DO NOT WRITE IN THIS AREA

(b) (i) State the process that causes the change in mass of the potato cylinders. (1)

.....

(ii) Explain how this process causes the change in mass of the potato cylinders. (2)

.....

.....

.....

(iii) Suggest why the potato cylinders are wrapped in filter paper at the start and at the end of the investigation. (2)

.....

.....

.....

(iv) Each cylinder was left in its solution for two hours.  
State two other factors that should be kept constant during this investigation. (2)

1 .....

.....

2 .....

.....

**(Total for Question 3 = 16 marks)**



4 The skeleton contains a number of joints.

(a) State what is meant by the term **joint**.

(1)

(b) The diagram shows a hinge joint.

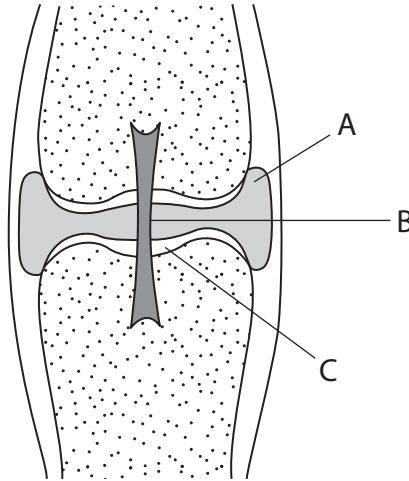

(i) Name parts A, B and C.

(3)

A.....

B.....

C.....

(ii) Describe the function of each of the parts A, B and C.

(6)

A.....

B.....

C.....

(Total for Question 4 = 10 marks)

DO NOT WRITE IN THIS AREA

DO NOT WRITE IN THIS AREA

DO NOT WRITE IN THIS AREA



- 5 During eating, food often becomes stuck between teeth. In an investigation, a student removes food particles from between his teeth. He places them into each of three test tubes, A, B and C. He adds an indicator to each test tube that changes to red in acid conditions, as shown in the table below. The colour of the indicator is recorded after one hour.

The student's results are shown in the table.

Test tube	Contents of test tube	Indicator colour after 1 hour
A	food particles + indicator	green
B	glucose + food particles + indicator	red
C	glucose + boiled food particles + indicator	green

- (a) (i) Explain which is the best temperature to carry out this investigation.

(3)

.....

.....

.....

.....

.....

.....

.....

- (ii) Explain the purpose of tube C.

(3)

.....

.....

.....

.....

.....

.....

.....

DO NOT WRITE IN THIS AREA

DO NOT WRITE IN THIS AREA

DO NOT WRITE IN THIS AREA



(b) The tubes are left for a further 24 hours. After this time the indicator in tube A becomes red.

Explain why this change occurs.

(2)

.....

.....

.....

.....

**(Total for Question 5 = 8 marks)**

DO NOT WRITE IN THIS AREA

DO NOT WRITE IN THIS AREA

DO NOT WRITE IN THIS AREA



- 6 (a) Organisms have different energy contents and may also contain insecticide.

The table shows the energy content and mass of insecticide in each organism in a food chain.

Organism	Energy content in arbitrary units	Mass of insecticide in mg per kg of body mass
humans	88	1.000
fish	1600	0.100
microscopic animals	14100	0.010
microscopic plants	87100	0.001

- (i) Calculate the mass of insecticide in a woman of mass 65 kg.

Give a unit.

(2)

mass of insecticide = ..... unit .....

- (ii) Calculate the percentage of energy transferred from fish to humans.

(2)

percentage = .....

DO NOT WRITE IN THIS AREA

DO NOT WRITE IN THIS AREA

DO NOT WRITE IN THIS AREA



(iii) Draw a food chain to include all the organisms in the table.

(2)

DO NOT WRITE IN THIS AREA

DO NOT WRITE IN THIS AREA

DO NOT WRITE IN THIS AREA

(b) Using the information in the table and your own knowledge, explain why food chains involving humans should remain short.

(4)

.....

.....

.....

.....

.....

.....

.....

.....

.....

.....

**(Total for Question 6 = 10 marks)**



7 (a) The passage describes the control of blood glucose.

Complete the passage by using the correct word or words.

(6)

Blood glucose concentration is regulated by ..... feedback involving hormones secreted by the ..... found in the pancreas. These contain alpha cells that detect a reduced blood glucose concentration, which as a result will secrete .....

This hormone returns the blood glucose concentration to normal by stimulating the conversion of ..... into .....

The beta cells detect a raised blood glucose concentration and secrete the hormone ..... which returns blood glucose levels to normal.

(b) Homeostasis is achieved by nervous and hormonal control.

Complete the table by giving four differences between nervous and hormonal control of the human body.

(4)

Nervous control	Hormonal control

(Total for Question 7 = 10 marks)

DO NOT WRITE IN THIS AREA

DO NOT WRITE IN THIS AREA

DO NOT WRITE IN THIS AREA

DO NOT WRITE IN THIS AREA

DO NOT WRITE IN THIS AREA

DO NOT WRITE IN THIS AREA

8 Sickle cell anaemia is a genetically inherited condition. People with this condition have red blood cells that are shaped differently from normal red blood cells.

The diagram shows blood cells passing through a capillary of a person with normal red blood cells and a person with sickled red blood cells.

normal red blood cells

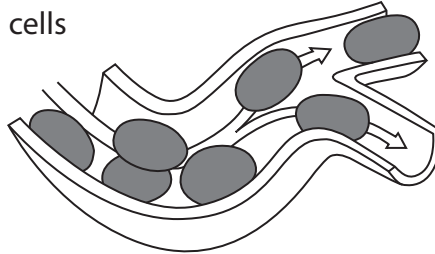

sickled red blood cells (sickle cells)

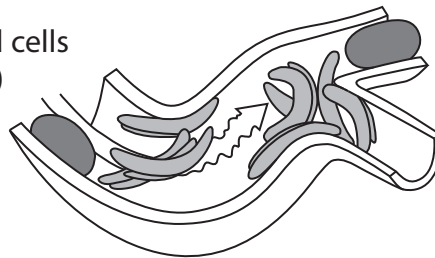

(a) (i) Using information from the diagram, explain the disadvantage of having the sickle cell condition.

(3)

.....

.....

.....

.....

.....

.....

(ii) State an advantage for people living in tropical areas of having the sickle cell allele.

(1)

.....



- (b) The diagram shows a family tree, some of whose members carry the allele for sickle cell anaemia.

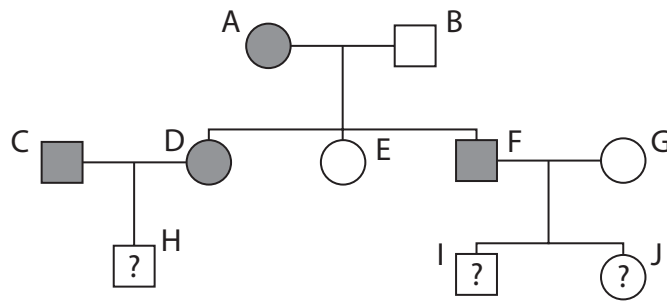

Key

○ Female not affected	□ Male not affected
● Female carrier	■ Male carrier
⊙ Female condition unknown	⊠ Male condition unknown

The allele for normal haemoglobin is N and the allele for sickle haemoglobin is n.

- (i) Explain how the family tree shows that sickle cell anaemia is not a sex linked condition.

(2)

- (ii) Explain what is meant by the term **carrier**.

(2)

- (iii) What is the genotype of person A in the family tree?

(1)

DO NOT WRITE IN THIS AREA

DO NOT WRITE IN THIS AREA

DO NOT WRITE IN THIS AREA



(iv) Explain who is the only person in the family tree who might have sickle cell anaemia.

(3)

.....

.....

.....

.....

.....

.....

.....

.....

.....

.....

**(Total for Question 8 = 12 marks)**

DO NOT WRITE IN THIS AREA

DO NOT WRITE IN THIS AREA

DO NOT WRITE IN THIS AREA



- 9 (a) The diagram shows a section through human skin.

The temperature of the air surrounding the skin is 4°C.

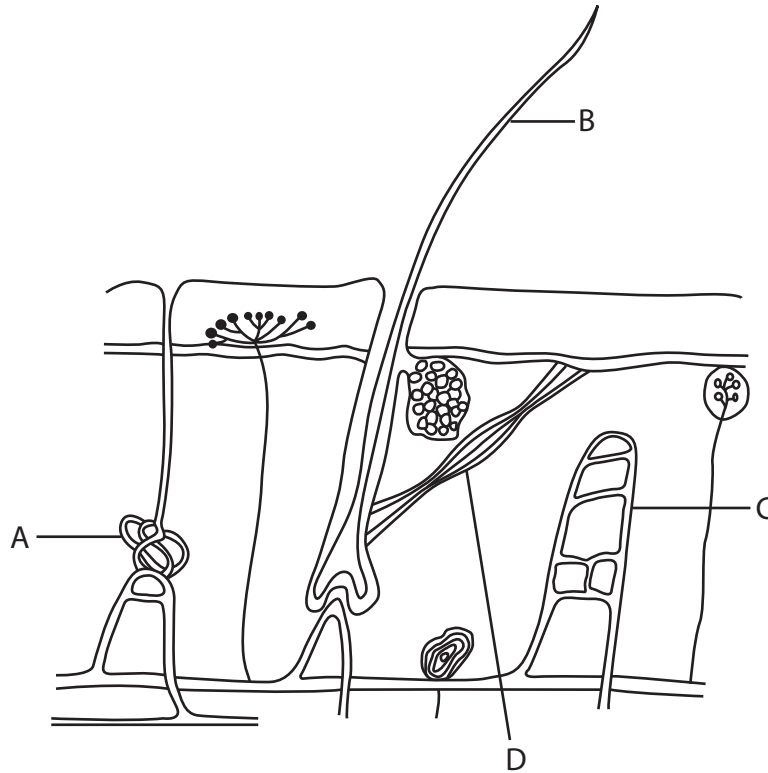

- (i) Name the structures A, B and C.

(3)

A .....

B .....

C .....

- (ii) Explain the function of structure D.

(1)

.....

.....

DO NOT WRITE IN THIS AREA

DO NOT WRITE IN THIS AREA

DO NOT WRITE IN THIS AREA



(iii) The air temperature increases to 25°C.

Describe how the appearance of structures B and C would change.

(2)

(iv) Explain why these changes occur.

(4)

(b) If the body temperature of a person drops, an uncontrolled contraction of the skeletal muscles occurs.

(i) Name this process of uncontrolled contraction of the skeletal muscles.

(1)

(ii) Describe how this process raises body temperature.

(3)

**(Total for Question 9 = 14 marks)**

DO NOT WRITE IN THIS AREA

DO NOT WRITE IN THIS AREA

DO NOT WRITE IN THIS AREA



**10** The diagrams show a sperm and an ovum.

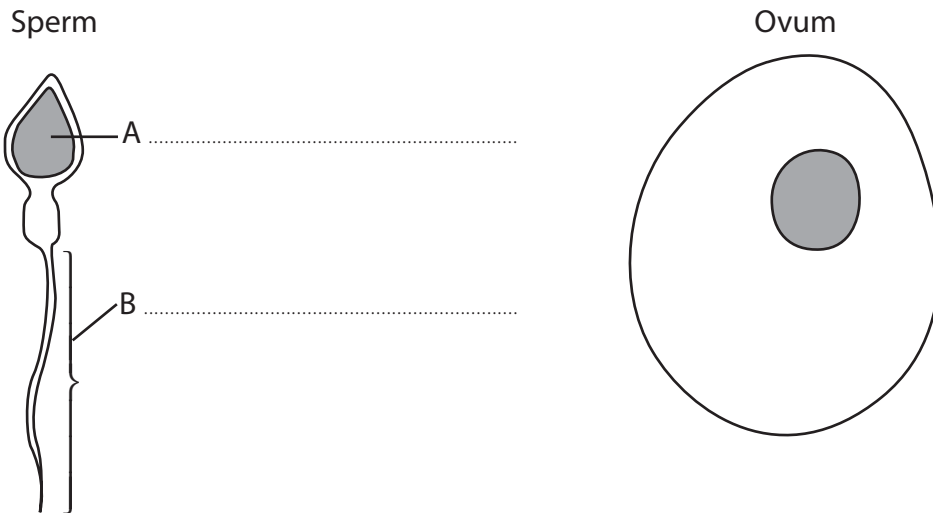

(a) On the diagram, name the parts of the sperm labelled A and B. (2)

(b) Describe how structures A and B help the sperm to carry out its functions. (2)

.....

.....

.....

.....

(c) Suggest two advantages of an ovum being much larger than a sperm. (2)

.....

.....

.....

.....

**(Total for Question 10 = 6 marks)**

DO NOT WRITE IN THIS AREA

DO NOT WRITE IN THIS AREA

DO NOT WRITE IN THIS AREA



DO NOT WRITE IN THIS AREA

DO NOT WRITE IN THIS AREA

DO NOT WRITE IN THIS AREA

**BLANK PAGE**



11 The diagram shows the human breathing system.

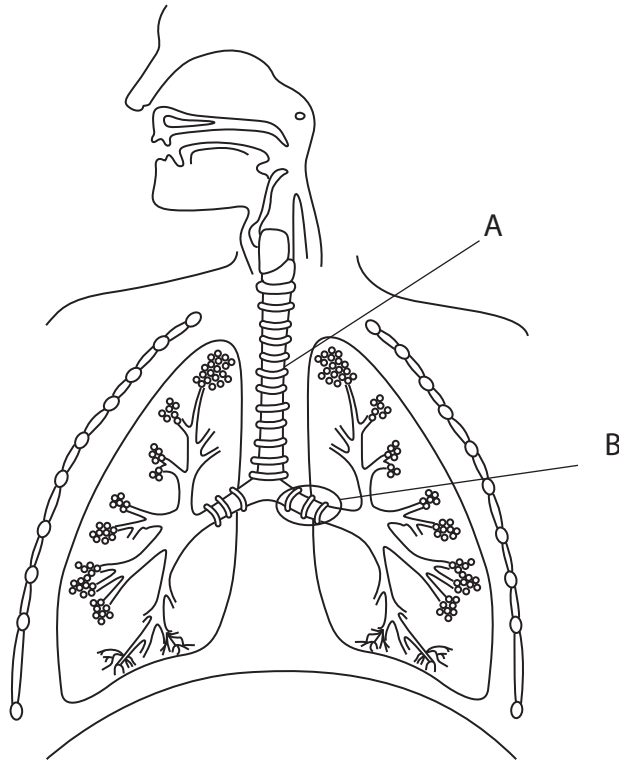

(a) Name the structures A and B.

(2)

A .....

B .....

(b) The table gives data for athletes running races of different distances.

Distance of race in metres	Oxygen needed in $\text{dm}^3$	Oxygen taken into the blood in $\text{dm}^3$
100	10	0.5
10 000	150	133



- (i) The oxygen debt is the difference between the amount of oxygen needed and the amount of oxygen taken into the blood.

Calculate the oxygen debt for an athlete running a 10 000 m race.  
Show your working.

(2)

oxygen debt ..... dm<sup>3</sup>

- (ii) Name a waste product only produced during the period of the oxygen debt.

(1)

- (iii) Explain why the time taken to repay the oxygen debt will be greater for an athlete running a 10 000 m race than for an athlete running a 100 m race.

(3)

---

**(Total for Question 11 = 8 marks)**

---

**TOTAL FOR PAPER = 120 MARKS**

DO NOT WRITE IN THIS AREA

DO NOT WRITE IN THIS AREA

DO NOT WRITE IN THIS AREA



DO NOT WRITE IN THIS AREA

DO NOT WRITE IN THIS AREA

DO NOT WRITE IN THIS AREA

**BLANK PAGE**



DO NOT WRITE IN THIS AREA

DO NOT WRITE IN THIS AREA

DO NOT WRITE IN THIS AREA

**BLANK PAGE**



DO NOT WRITE IN THIS AREA

DO NOT WRITE IN THIS AREA

DO NOT WRITE IN THIS AREA

**BLANK PAGE**

Every effort has been made to contact copyright holders to obtain their permission for the use of copyright material. Pearson Education Ltd. will, if notified, be happy to rectify any errors or omissions and include any such rectifications in future editions.

